

Model AMT-Ex

Intrinsically Safe 4-20mA Dewpoint Transmitter

Model AMT-Ex Dew-point Transmitter is a 3-wire 4-20mA transmitter, used for continuous measurement of humidity in dry process gases or dry compressed air. The **Model AMT-Ex** transmitter can also be factory configured to output a linear 4-20mA signal for any other moisture unit e.g. ppm(v), ppm(w), g/m³ and lb/MMSCF etc.

Fast Response - Stable - Reliable - Accurate - Easy to Install.

The long lasting sensing element offers excellent sensitivity, repeatability and speed of response. Each unit is supplied with a Certificate of Calibration, traceable to International Humidity Standards.



CE
Measuring instrument
conforms with
BS EN 61326-1

FEATURES

- 3 Wire Intrinsically Safe Dewpoint Transmitter
-  II 1GD Ex ia IIC T4 Ex iaD 20 T135°C (-20°C ≤ Ta ≤ +60°C)
- Overall Range: -120°C to +20°C Dewpoint
- Accuracy ± 2°C Dewpoint
- INTEGRATED AUTOMATIC CALIBRATION
- Can be configured for Linear 4-20mA signal in: °C & °F Dewpoint, ppm(v), g/m³, lb/MMSCF
- Fault Diagnostics
- Long Term Stability
- Fast Response time
- IP66 / NEMA4X Protection

Model AMT-Ex is ATEX certified and provides an Intrinsically Safe Dew Point Transmitter for hazardous area use when installed with the appropriate isolator. See Illustration opposite and additional information on pages 2 and 4.

This online dew point transmitter also incorporates an Automatic Calibration (AUTOCAL) feature that allows the user to carry out a field calibration / span check. The **AUTOCAL feature** is operated by two small button switches built within the transmitter enclosure.

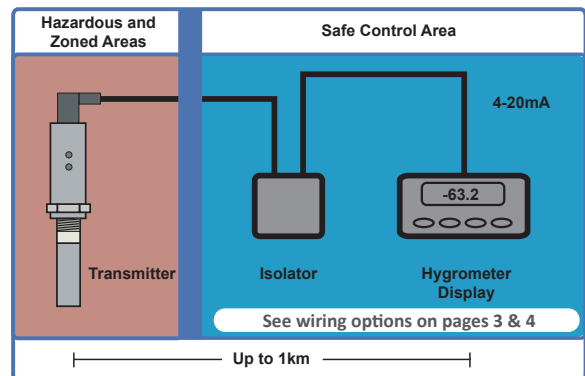

The integral RISC microprocessor circuitry of the **Model AMT-Ex** transmitter allows high resolution with advanced self diagnostics for fault conditions. It also enables periodic re-calibration of the moisture sensor, storing calibration data within the fully self contained unit. The mechanics of the **Model AMT-Ex** transmitter have been designed to cope with extreme environmental conditions. The rugged stainless steel construction offers protection to IP66 (NEMA4X), with the transmitter electrical connections made via a secure industrial connector.

Model AMT-Ex transmitter can withstand 35,000 kPa (350bar) maximum pressure and by employing a low resistance cable, the transmitter can be located at significant distances in excess of 1000 metres from the control room.

The **Model AMT-Ex** transmitter is supplied with a Certificate of Calibration, an instruction manual and 2m connecting cable.

Dew-point Sampling Systems available - see www.amsystems.co.uk for more details.

Specifications

MODEL AMT-Ex Dewpoint Transmitter

TRANSMITTER TYPE: 3 Wire, 4-20mA Loop Powered Transmitter
OUTPUT SIGNAL: 4 to 20mA Linear with selectable engineering units
OPERATING VOLTAGE: 12-28V dc. Reverse polarity protected.
SENSING ELEMENT: Ultra High Capacitance - Aluminium Oxide Type
RANGES: See How to Order Step 1 Below
INTRINSIC SAFETY CERTIFICATION STANDARDS:
 EN 60079-0:2012 EN 60079-11:2012

Ex Certification: ATEX and IECEx Markings: IECEx BAS 07.0080
 Ex II 1GD Ex ia IIC T4 Ex iaD 20 T135°C (-20°C ≤ Ta ≤ +60°C).

AUTOCAL: Field calibration / Span check facility. Activated and operated via two button switches on the Transmitter body. Locked in normal operating mode to avoid tamper.

FACTORY CALIBRATION: Supplied with Certificate of Calibration traceable to NPL / NIST

ACCURACY: ± 2°C dewpoint (NPL/NIST traceable for range -90°C to +20°C)

REPEATABILITY: Better than ±0.3°C dewpoint

OPERATING TEMPERATURE: -20°C to +60°C

STORAGE TEMPERATURE: -20°C to +70°C

OPERATING PRESSURE: From 1kPa (0.01 barA) to Maximum 35,000kPa (350 barA)

OPERATING HUMIDITY (External): Maximum - 95% RH

Non-condensing

SAMPLE FLOW RATE: Flow independent but ideally 2 to 5 litres per minute. Max: 25 litres/min.

CABLE TERMINATIONS: IP66 (NEMA4X) rated, size C, DIN EN 175301 connector at the Transmitter and other end terminated with bootlace ferrules.

CABLE: Supplied with 2m IS (blue) standard cable. Nominal diameter 3.4mm, 92ohms/km at 20°C

ELECTROMAGNETIC COMPATIBILITY (EMC):

Complies with BS EN 61326-1

WARM UP TIME: 10 seconds

FAULT CONDITIONS:

Open Circuit : Output drives to 20.50mA

Short Circuit : Output drives to 20.75mA

System Error: Output drives to 21.00mA

ISOLATION: Sensing Element connected to the 4-20mA loop but isolated from Transmitter body.

TRANSMITTER ENCLOSURE: 316 Stainless steel body with size C, DIN EN 175301 connector.

SENSOR PROTECTION: 316 Sintered stainless steel filter - 50 micron

PROBE MATERIAL (WETTED PARTS): 316 Stainless Steel

WEATHERPROOF CLASSIFICATION: IP66 / NEMA4X when Connector mated to Transmitter.

MECHANICAL CONNECTION: 3/4" UNF (16tpi) with integral Viton "O" ring seal.

MECHANICAL WARRANTY: 24 months in case of faulty workmanship and defective parts.

How to Order - Step 1 of 5

Select a Range Below

Model AMT-Ex + [XX]

SR: -110°C to -20°C (-166°F to -4°F) dewpoint
PL: -100°C to 0°C (-148°F to +32°F) dewpoint
RD: -80°C to -20°C (-112°F to -4°F) dewpoint
GY: -80°C to 0°C (-112°F to +32°F) dewpoint

resolution = 0.1°C / °F

SD: -100°C to +20°C (-148°F to +68°F) dewpoint
LD: -120°C to +20°C (-184°F to +68°F) dewpoint
HD: -65°C to +20°C (-85°F to +68°F) dewpoint

resolution = 0.1°C / °F

SP: 1 to 1000 ppm(v) ---- resolution = 1ppm
MP: 0.1 to 100.0 ppm(v) ---- resolution = 0.1ppm
LP: 0.01 to 10.00 ppm(v) ---- resolution = 0.01ppm

PB: 1 to 1000 ppb(v) ---- resolution = 1ppb

HG: 0.01 to 10.00 g/m3 ---- resolution = 0.01g/m3

LG: 0.001 to 1.000 g/m3 ---- resolution = 0.001g/m3

LB: 0.1 to 100.0 lbs/MMSCF - resolution = 0.1 lbs/MMSCF

NOTE: ppm, ppb, g/m3 & lbs/MMSCF ranges are stated at atmospheric pressure. Model AMT-Ex Transmitter can be configured to provide corresponding ranges for operation at other constant pressure. This must be stated at time of order.

Order Example:- Dewpoint Transmitter Model AMT-Ex-SD = -100°C to +20°C dp
 Model AMT-Ex COMES COMPLETE WITH A STANDARD 2 METRE CONNECTING CABLE.

Range



How to Order - Step 2 of 5

Select a Longer Cable Below

CAB110-AMT-Ex + [XX]

Your AMT-Ex Transmitter comes complete with 2 metres of connecting cable as standard.

To order a longer length in metres, add number after this part number.

Example: CAB110-AMT-Ex-10 for 10m

Non-Standard off the shelf cables available in 3, 4, 5, 10, 12, 15, 25m lengths. For longer lengths please call.

AMT-Ex Standard Cable 2 Meters

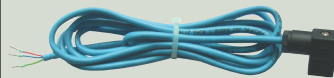

Part No. CAB110-AMT-Ex

Length

How to Order - Step 3 of 5

Order a Display Below (optional)

Model DS1200



For more details please see data sheet DS1200.

- Perfect for continuous in-line measurements
- Fast Response
- 22V – 253VAC 50/60Hz or 20 to 300V DC operation
- Single channel in-line hygrometer
- Panel protection to IP65 (NEMA4X)
- 2 independent alarms
- 4-20mA re-transmission

How to Order - Step 4 of 4

Select a Transmitter Holder Comes complete with mounting plate.

2 grades available: 303 or 316 Stainless Steel

ADSH-AMT 303 + [X] [X]
 ADSH-AMT 316 + [X] [X]

X = Choose INLET Pipe Fitting
 0 = None 1/8" NPT Port
 4 = 1/4" - Pipe OD
 8 = 1/8" - Pipe OD
 6 = 6mm - Pipe OD

X = Choose OUTLET Pipe Fitting
 0 = None 1/8" NPT Port
 4 = 1/4" - Pipe OD
 8 = 1/8" - Pipe OD
 6 = 6mm - Pipe OD

Order Example:- For Transmitter Holder 303 grade with 2 x 1/4 fittings Order ADSH-AMT 303 - 4 - 4

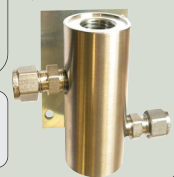

How to Order - Step 5 of 5

Order an Isolator for the safe area

Part No. PR5104BB2A - Single Channel

Part No. PR5104BB2B - Dual Channel



See Page 4 for wiring diagrams

Dimensions

Model AMT-Ex Dewpoint Transmitter

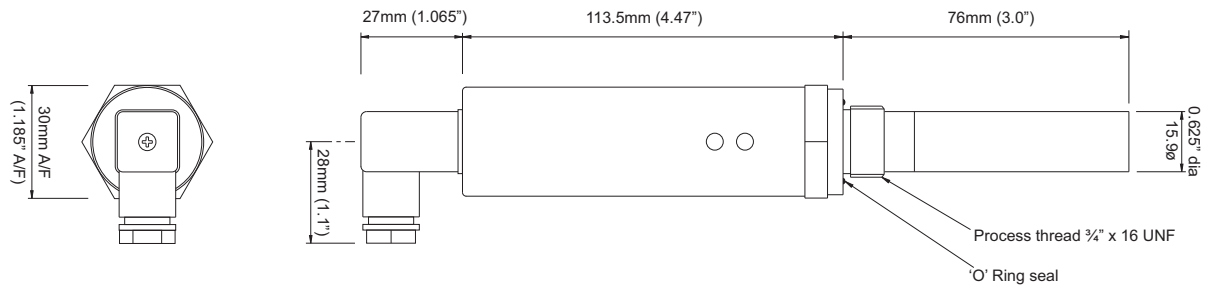

Model ADSH-AMT Transmitter Holder Flow Through Sample Cell

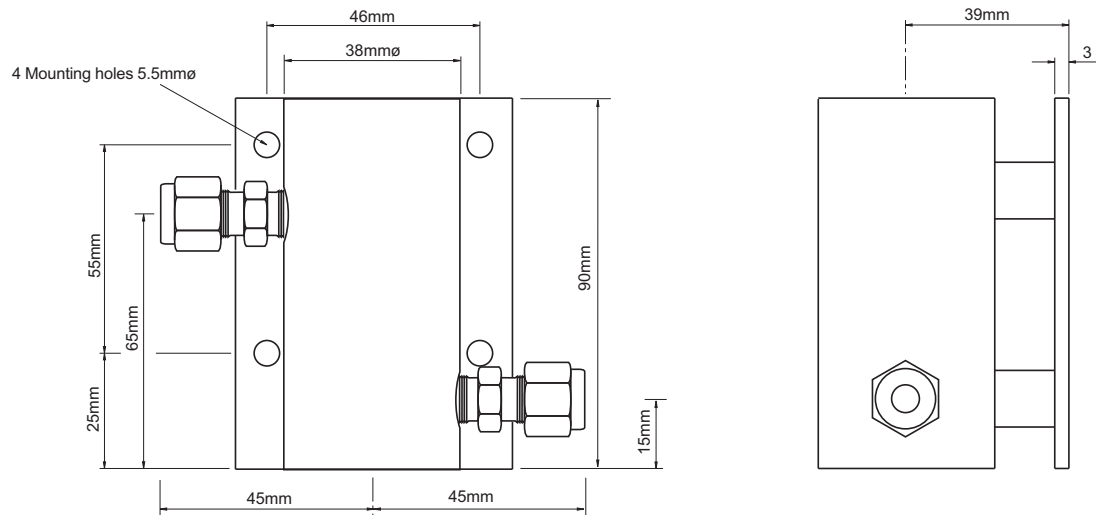

Note: The Assembly is shown with 1/4" OD tube fittings. The dimensions across the tube fittings will vary for all other size fittings.

Model DS1200 Display

Stable, Accurate and Reliable Alarmed Monitor

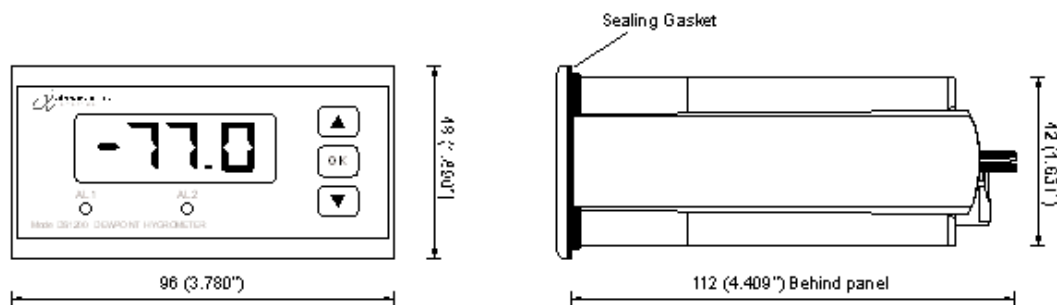

Panel out-out: 44.5 x 91.5 (1.752" x 3.602")

Maximum panel thickness: 10mm (0.394")

Application Wiring Diagrams

Model AMT-Ex Dewpoint Transmitter Using PR5104BB2A Single Isolator and Model DS1200 Display

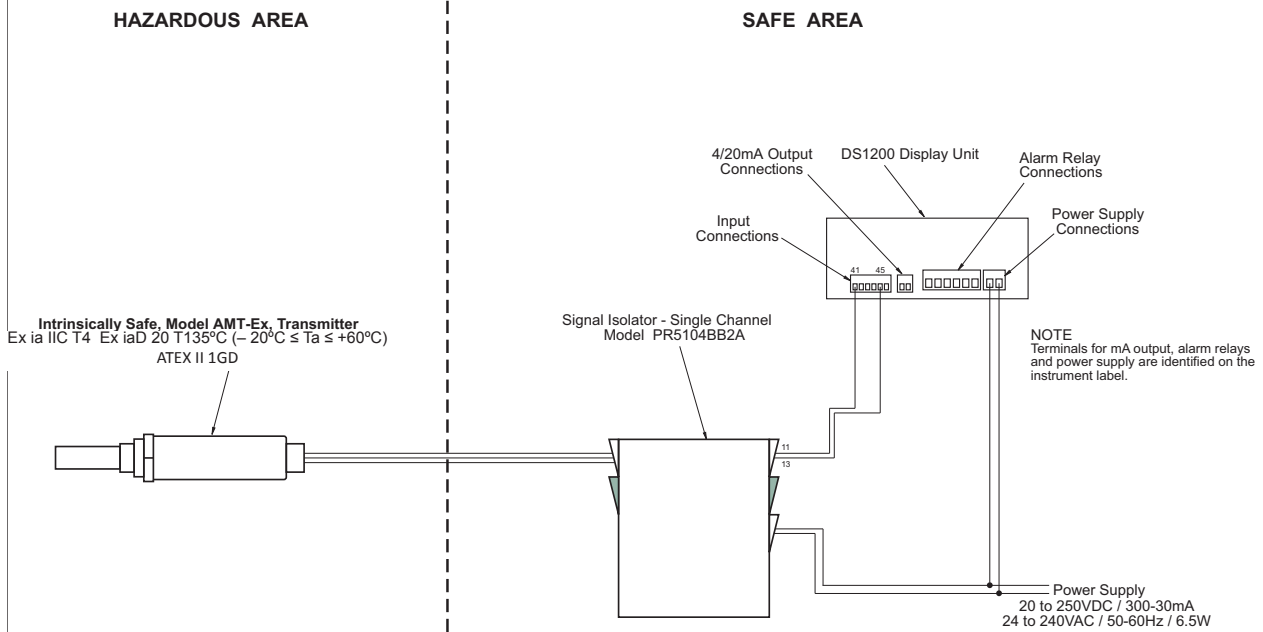

Model AMT-Ex Dewpoint Transmitter Using PR5104BB2B Dual Isolator and Model DS1200 Display

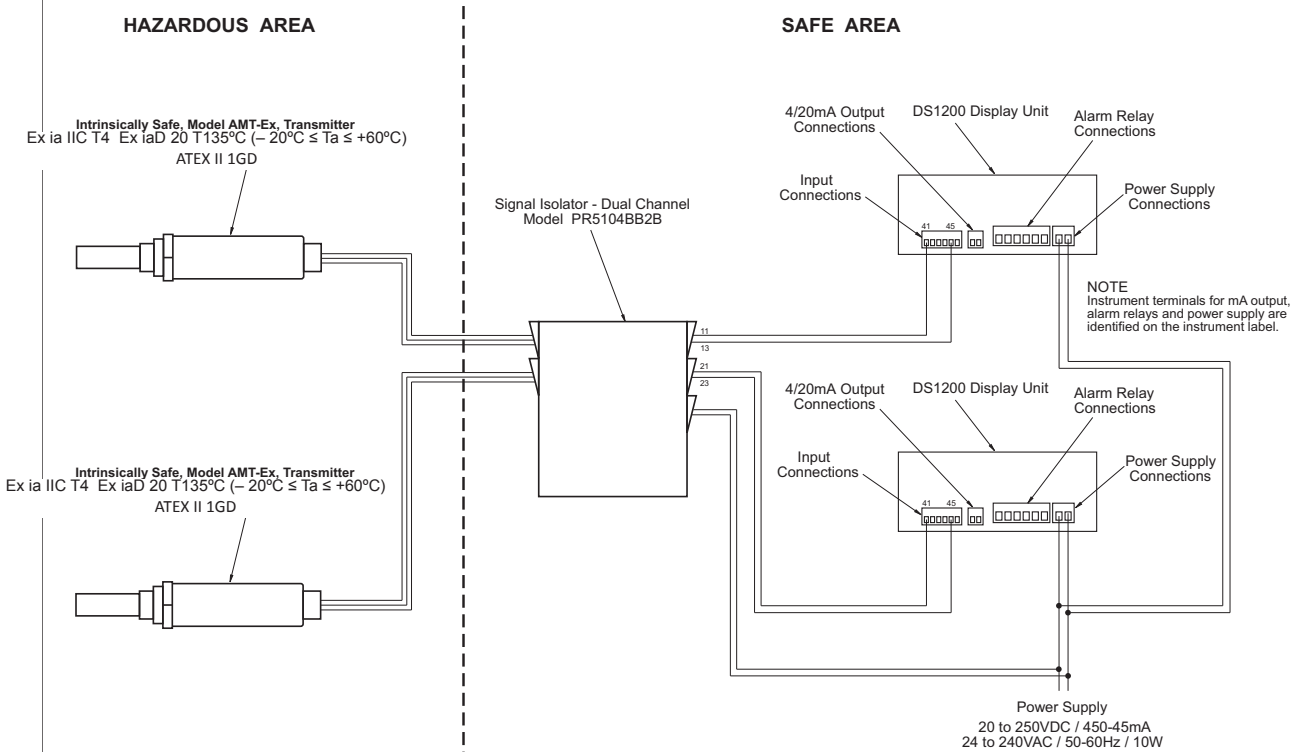

NOTE: The Model AMT-Ex is not suitable for Ammonia (NH₃), Chlorine (Cl) - and Hydrogen Chloride (HCl). See Model EDM data sheets for products. Sulphur Dioxide (SO₂) can be monitored if the moisture content is low, less than 100ppm(v). SF₆ can be monitored with no effect to the sensor element.

For more information on our ATEX Certified Ex product range please contact us
on +44 (0) 1274 733 100 or Email: info@amsystems.co.uk

Product specification may be subject to change, without prior notice, as part of our ongoing product development programme.

2151 Model AMT-Ex pd210416 -Iss-3



Alpha Moisture Systems Limited. Registered Office: Alpha House, 96 City Road, Bradford, BD8 8ES
Registered in England and Wales No. 3902302 - VAT Registration No. GB 607 2075 63 - WEEE Producer Registration No. WEEE/EA0067TX

Tel	+44 (0) 1274 733100
Fax	+44 (0) 1274 733200
Email	info@amsystems.co.uk
Website	www.amsystems.co.uk